

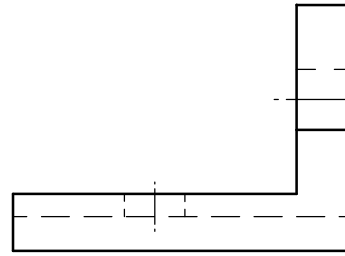

Corso di Laurea in Ingegneria

Metodi di Rappresentazione Tecnica

Esercitazione 3: disegnare gli oggetti rappresentati a mano libera, su carta bianca formato A2, in proiezione assonometrica isometrica, dimetrica o cavaliera.

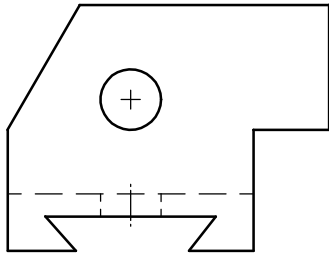

a)

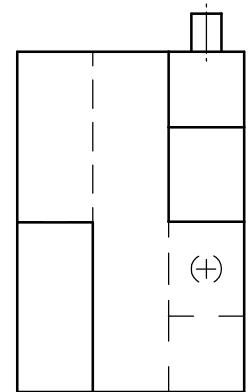
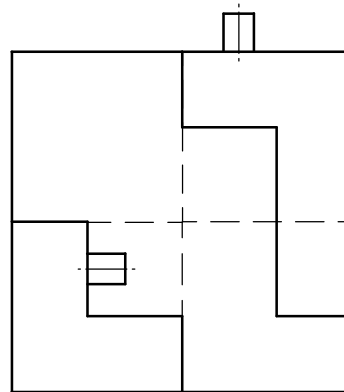
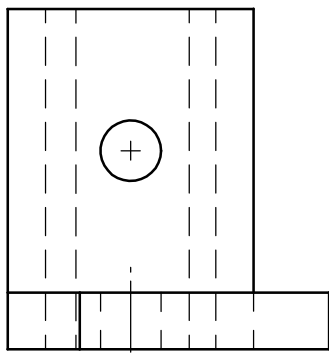

b)

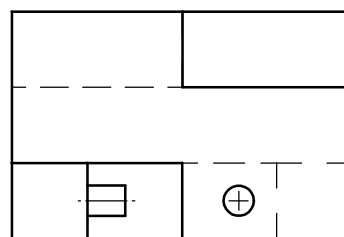
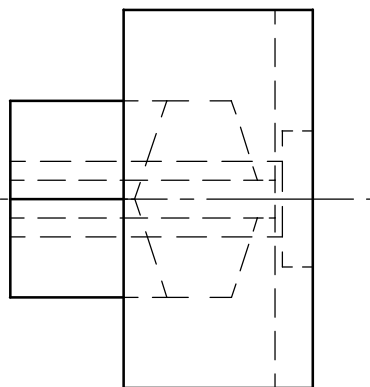

c)

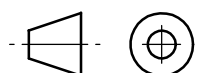
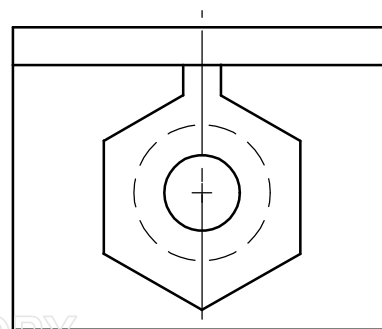
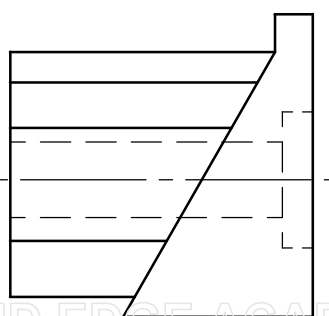



Corso di Laurea in Ingegneria

Metodi di Rappresentazione Tecnica

Esercitazione 3: disegnare gli oggetti rappresentati a mano libera, su carta bianca formato A2, in proiezione assonometrica isometrica, dimetrica o cavaliera.

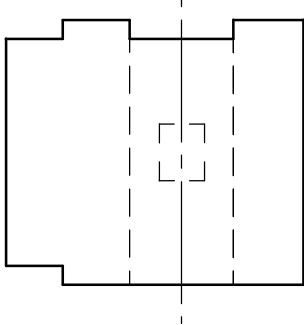

d)

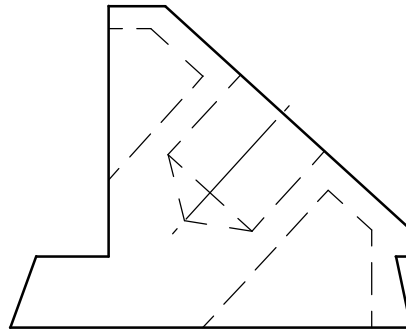

e)

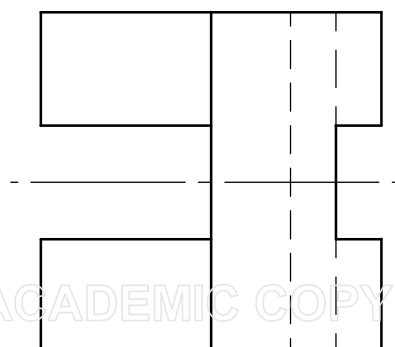
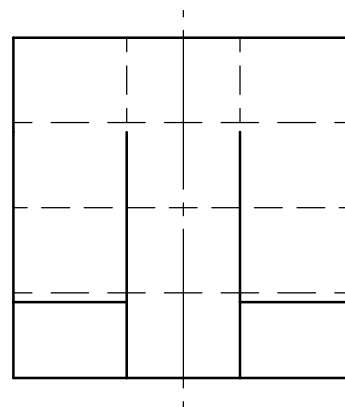
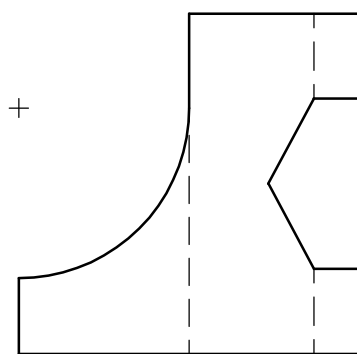
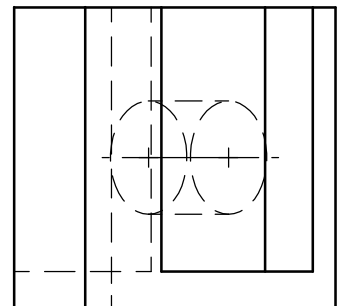
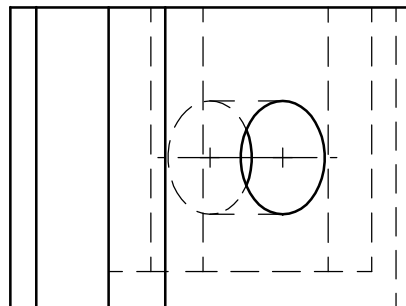
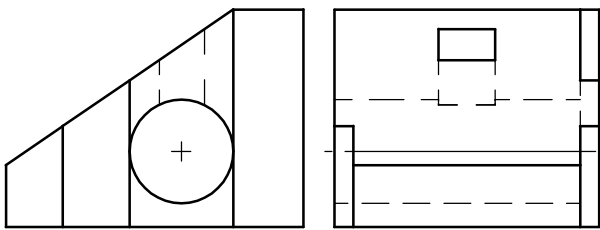

f)

